

Dual Common Cathode diodes Power Module

$V_{RRM} = 1000V$
 $I_C = 400A @ T_c = 70^\circ C$

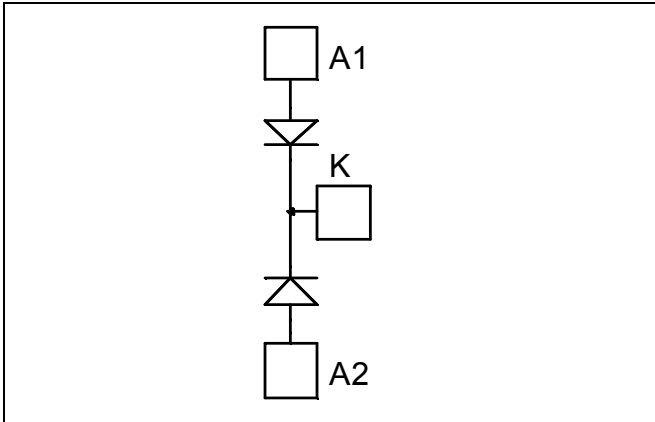

Application

- Uninterruptible Power Supply (UPS)
- Induction heating
- Welding equipment
- High speed rectifiers

Features

- Ultra fast recovery times
- Soft recovery characteristics
- High blocking voltage
- High current
- Low leakage current
- Very low stray inductance
 - Symmetrical design
 - M5 power connectors
- High level of integration

Benefits

- Outstanding performance at high frequency operation
- Low losses
- Low noise switching
- Direct mounting to heatsink (isolated package)
- Low junction to case thermal resistance
- RoHS Compliant

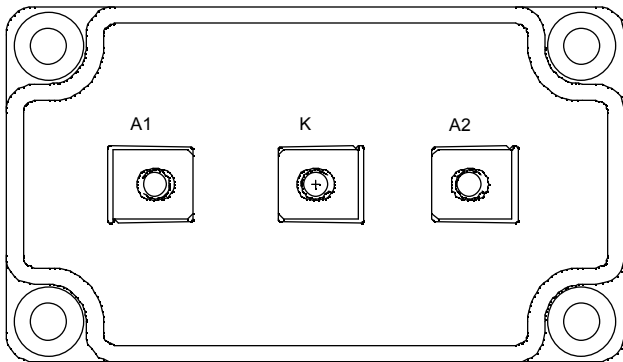

Absolute maximum ratings

| Symbol | Parameter | | | Max ratings | Unit |
|--------------|---|------------------|--------------------|-------------|------|
| V_R | Maximum DC reverse Voltage | | | 1000 | V |
| V_{RRM} | Maximum Peak Repetitive Reverse Voltage | | | | |
| $I_{F(AV)}$ | Maximum Average Forward Current | Duty cycle = 50% | $T_C = 25^\circ C$ | 500 | A |
| | | | $T_C = 70^\circ C$ | 400 | |
| $I_{F(RMS)}$ | RMS Forward Current | Duty cycle = 50% | $T_C = 45^\circ C$ | 500 | |
| I_{FSM} | Non-Repetitive Forward Surge Current | 8.3ms | $T_C = 45^\circ C$ | 3000 | |

CAUTION: These Devices are sensitive to Electrostatic Discharge. Proper Handling Procedures Should Be Followed. See application note APT0502 on www.microsemi.com

All ratings @ $T_j = 25^\circ\text{C}$ unless otherwise specified

Electrical Characteristics

| <i>Symbol</i> | <i>Characteristic</i> | <i>Test Conditions</i> | | <i>Min</i> | <i>Typ</i> | <i>Max</i> | <i>Unit</i> |
|---------------|---------------------------------|------------------------|---------------------------|------------|------------|------------|---------------|
| V_F | Diode Forward Voltage | $I_F = 400\text{A}$ | | | 2.1 | 2.7 | V |
| | | $I_F = 600\text{A}$ | | | 2.3 | | |
| | | $I_F = 400\text{A}$ | $T_j = 125^\circ\text{C}$ | | 1.7 | | |
| I_{RM} | Maximum Reverse Leakage Current | $V_R = 1000\text{V}$ | $T_j = 25^\circ\text{C}$ | | | 250 | μA |
| | | | $T_j = 125^\circ\text{C}$ | | | 1000 | |
| C_T | Junction Capacitance | $V_R = 1000\text{V}$ | | | 480 | | pF |

Dynamic Characteristics

| <i>Symbol</i> | <i>Characteristic</i> | <i>Test Conditions</i> | | <i>Min</i> | <i>Typ</i> | <i>Max</i> | <i>Unit</i> |
|---------------|--------------------------|--|---------------------------|------------|------------|------------|---------------|
| t_{rr} | Reverse Recovery Time | $I_F = 1\text{A}, V_R = 30\text{V}$ $di/dt = 400\text{A}/\mu\text{s}$ | $T_j = 25^\circ\text{C}$ | | 45 | | ns |
| t_{rr} | Reverse Recovery Time | $I_F = 400\text{A}$ $V_R = 667\text{V}$ $di/dt = 800\text{A}/\mu\text{s}$ | $T_j = 25^\circ\text{C}$ | | 290 | | ns |
| | | | $T_j = 125^\circ\text{C}$ | | 340 | | |
| Q_{rr} | Reverse Recovery Charge | | $T_j = 25^\circ\text{C}$ | | 2.7 | | μC |
| | | | $T_j = 125^\circ\text{C}$ | | 14.6 | | |
| I_{RRM} | Reverse Recovery Current | | $T_j = 25^\circ\text{C}$ | | 24 | | A |
| | | | $T_j = 125^\circ\text{C}$ | | 72 | | |
| t_{rr} | Reverse Recovery Time | $I_F = 400\text{A}$ $V_R = 667\text{V}$ $di/dt = 4000\text{A}/\mu\text{s}$ | $T_j = 125^\circ\text{C}$ | | 160 | | ns |
| Q_{rr} | Reverse Recovery Charge | | | | 28.4 | | μC |
| I_{RRM} | Reverse Recovery Current | | | | 280 | | A |

Thermal and package characteristics

| <i>Symbol</i> | <i>Characteristic</i> | <i>Min</i> | <i>Typ</i> | <i>Max</i> | <i>Unit</i> | |
|---------------|--|---------------|------------|------------|---------------------------|-----|
| R_{thJC} | Junction to Case | | | 0.14 | $^\circ\text{C}/\text{W}$ | |
| V_{ISOL} | RMS Isolation Voltage, any terminal to case $t = 1\text{ min}$, $I_{isol} < 1\text{mA}$, 50/60Hz | 2500 | | | V | |
| T_j | Operating junction temperature range | -40 | | 175 | $^\circ\text{C}$ | |
| T_{STG} | Storage Temperature Range | -40 | | 125 | | |
| T_C | Operating Case Temperature | -40 | | 100 | | |
| Torque | Mounting torque | To heatsink | M6 | 3 | 5 | N.m |
| | | For terminals | M5 | 2 | 3.5 | |
| Wt | Package Weight | | | 280 | g | |

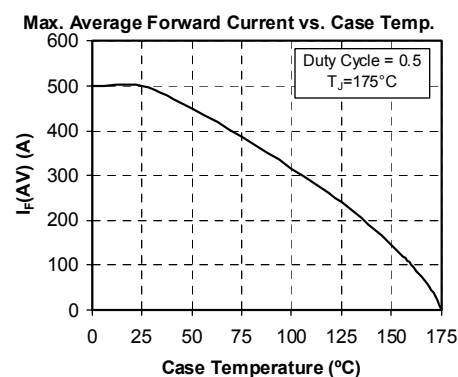
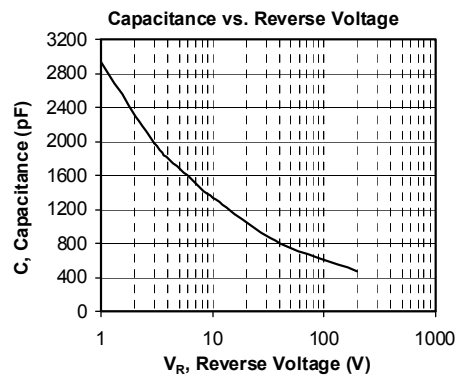
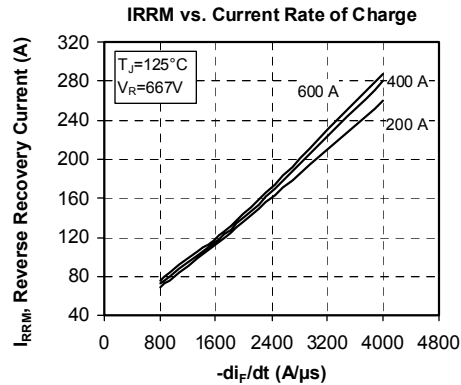
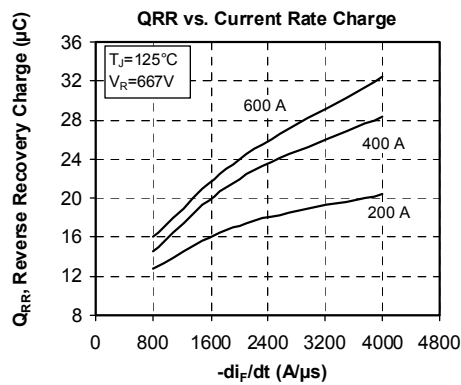
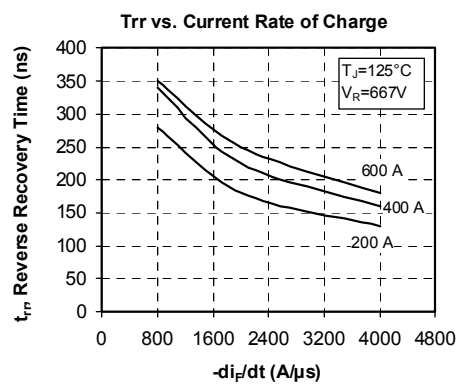
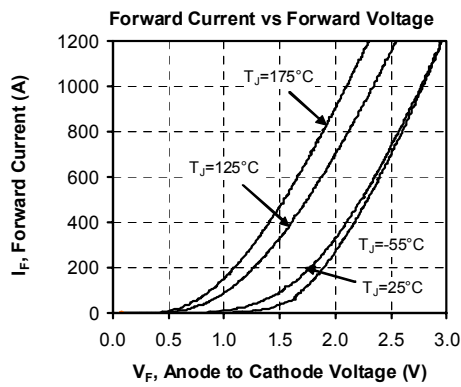
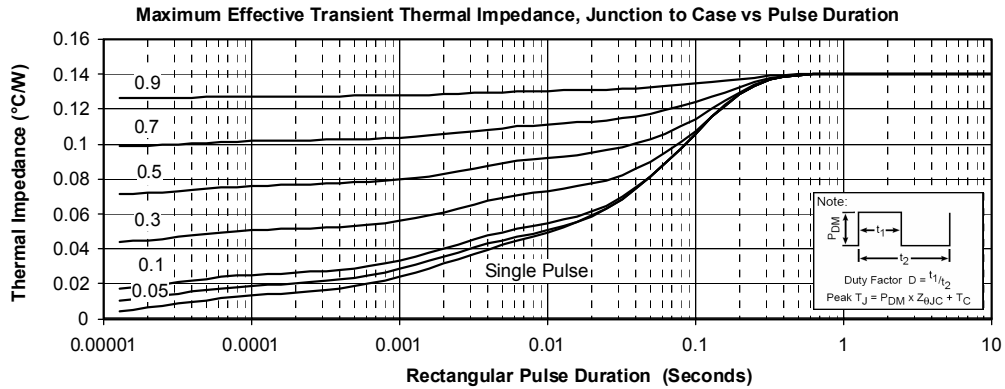
Typical Performance Curve

SP6 Package outline (dimensions in mm)



Microsemi reserves the right to change, without notice, the specifications and information contained herein

Microsemi's products are covered by one or more of U.S. patents 4,895,810 5,045,903 5,089,434 5,182,234 5,019,522 5,262,336 6,503,786 5,256,583 4,748,103 5,283,202 5,231,474 5,434,095 5,528,058 and foreign patents. U.S. and Foreign patents pending. All Rights Reserved.